

SPECIFICATION FOR APPROVAL

產品確認書/製品仕様書

FILE SERIAL NO./文件序號:	XSG2020918146040-L01
CUSTOMER / 客 戶:	
ARTICLE / 品 名:	SWITCHING POWER SUPPLY/CHARGER
MODEL NO. / 機種型號:	XSG1464000
PARAMETER / 規 格:	14.6V 4A
CERTIFICATE/認證:	UL,CUL,FCC,CE,GS,SAA,RCM,C-TICK,KC,PSE,CCC,ROHS
ISSUE DATE / 發行日期:	2020/9/18

Please to sign back after you confirm

承認書確認後請回簽一份

この仕様書をご確認とご署名の上、対象の営業窓口にご返信いただきますよう宜しくお願い致します。

CUSTOMER AUTHORIZED 客戶確認		
Approved by	Checked by	Prepared by

SUPPLIER AUTHORIZED 供方確認		
Approved by	Checked by	Prepared by
李麗敏	賀子豐	張文娟

*感謝您的支持，我們十分珍惜每次合作機會

*Thank you for your support,we will treasure the opportunity to cooperate with you

Rev.版本	Description of change/ 變更內容描述		Changed Date 日期	Approved
	Before(變更前)	After/變更後		
A	Original Release(初次發行)		2007/8/26	李麗敏
B	Label updated(標貼版本變更)		2010/6/20	王曉
C	Certificates updated(證書更新)		2018/1/22	李麗敏



* Make practical and safe power supply, Be enterprise with honesty and responsibility

* 提供實用安全的電源，做誠信負責的企業

* 実用的、安全な電源を提供し、誠実と信用、責任を持つ企業。

Table of Content(目錄)

1.SAFETY STANDARD / 安規標準	3
2.INPUT FEATURE / 輸入特性	3
3.CHARGER OUTPUT VOLTAGE / CURRENT FEATURE/ 充電器輸出電壓 / 電流的特性	3
4.Work Status of LED indicator/LED燈工作狀態顯示	3
5.CHARGING CURVE/充電曲線圖	4
6.PROTECTION FEATURE / 保護特性	4
7.ENVIRONMENTAL CONDITIONS / 環境條件	5
8.EMC STANDARDS / 電磁相容性標準	5
9.RELIABILITY AND QUALITY CONTROL / 可靠性及品質控制	6
10.WEIGHT / 重量	6
11.MECHANICAL REQUIREMENT / 結構參數	6
12.INSULATION RESISTANCE / 絕緣阻抗	6
13.LEAKAGE CURRENT / 漏電流	6
14.MAJOR MEASURE EQUIPMENT / 測量設備; VERIFIED BY THE THIRD LAB/外校	6
15.PRODUCT OUTLINE DIMENSION / 產品外觀尺寸	7
16.AC CORD / 輸入電源線	8
16.DC CORD / 輸出線材	9
17.RATING LABEL / 銘牌	10

EDITION	C	PAGE	2/10
----------------	----------	-------------	-------------

ELECTRICAL PERFORMANCE / 電器性能

1.SAFETY STANDARD / 安規標準

- 1.1 The green mode power supply shall be certified by the following international regulatory standards: 充電器應符合下列的國際標準：

Certificate 證書	Country 國家	Standard/安規標準	Certificate 證書	Country 國家	Standard/安規標準
■ UL/cUL	USA/CA 北美	UL/CSA62368-1; UL/CSA60950-1;	■ FCC	USA	FCC Part 15 Sub-part B
■ LVD/ GS	Germany 德國	EN60950; EN62368 EN 61558;EN60335	■ CE	Europe 歐洲	EN55032;EN55024; EN55020;EN61000; EN55014;
■ CB	Global 全球	IEC62368;IEC60950; IEC61558;IEC60335	■ KC	Korea 韓國	K60950-1
■ PSE	Japan 日本	J60950-1; J61558	■ SAA/RCM	AU 澳洲	AS/NZS 60950



2.INPUT FEATURE / 輸入特性

- 2.1 INPUT VOLTAGE RANGE: 90Vac to 264Vac. 輸入電壓範圍可以從90Vac到264Vac.
- 2.2 RATED INPUT VOLTAGE: 100Vac to 240Vac. 額定輸入電壓從100Vac到240Vac.
- 2.3 INPUT FREQUENCY RANGE: 47Hz to 63Hz. 輸入頻率範圍從47Hz到63Hz.
- 2.4 INPUT CURRENT: 1.3A max.&100-240Vac. 最大輸入電流1.3A(輸入條件100-240Vac)
- 2.5 INRUSH CURRENT: 60A max. at 100-240Vac input for a cold start at 25 °C.在准開機條件下，最大浪湧電流不超過60A (輸入條件100-240Vac).
- 2.6 EFFICIENCY: higher than 87% at 100-240Vac input and output full load. 效率高於87% (輸入100-240Vac 和輸出滿載條件) .
- 2.7 No-Load Input Power Dissipation/輸入空載功率損耗: Input 115Vac or 230Vac,output no load, the input power loss is less than 0.5W. 輸入115/230V交流，在空載時，輸入功耗小於0.5W.

3.OUTPUT/輸出特性

Charging Status 充電狀態	Charging Stage 充電階段	Output current 輸出電流(A)	Output voltage 輸出電壓(V)	LED indicator 指示燈
1.Charging 充電中	Constant Current 恒流	4.0A	8V-14.6V	Red
	Constant Voltage 恒壓	4.0A->0.4A	14.6V	Red
2.Charged full 充滿	Trickle Charging 涓流	0.4A->0	14.6V	Green

4.Work Status of LED indicator/LED燈工作狀態顯示

- No load output:Green Light 空載輸出:綠燈 
- In Process of Charging:Red Light 充電中:紅燈 
- Charged Full: Green Light 充滿:綠燈 

EDITION	C	PAGE	3/10
----------------	----------	-------------	-------------

5.CHARGING CURVE/充電曲線圖:

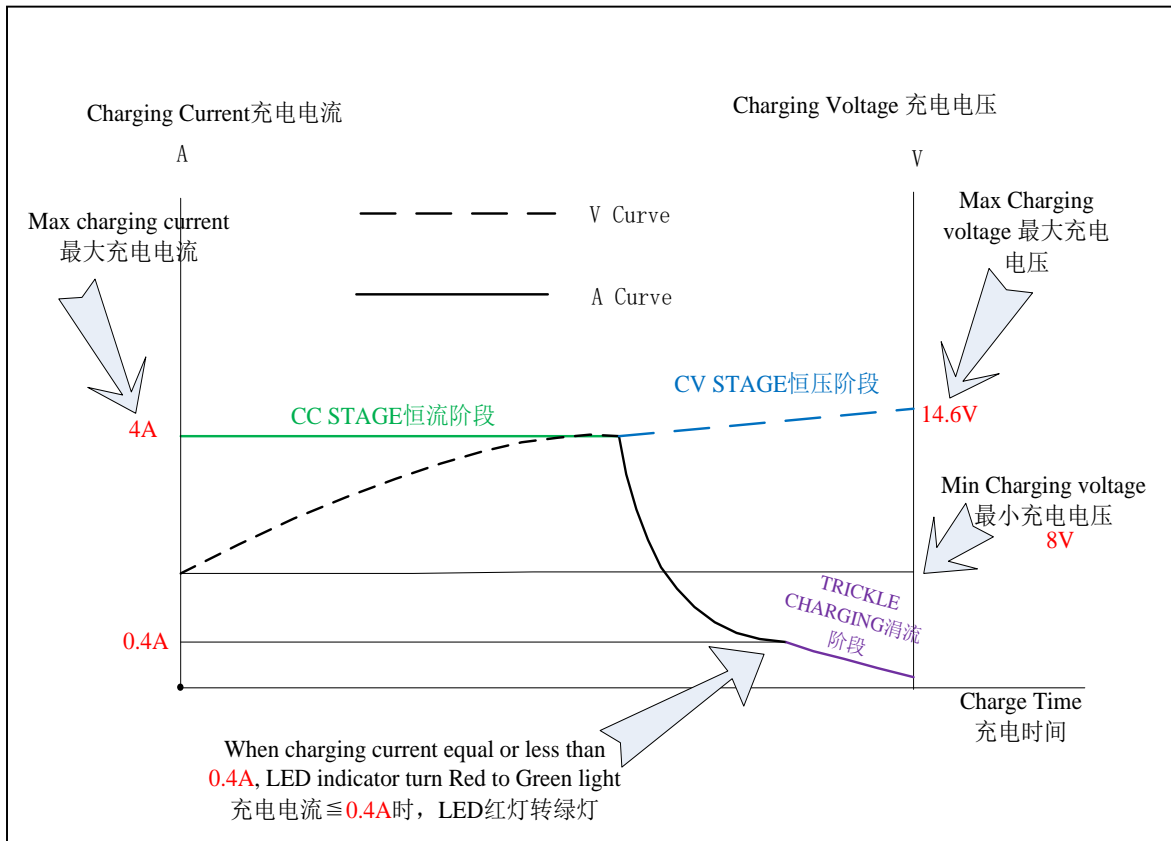

6.PROTECTION FEATURE / 保護特性

6.1 OVER—CURRENT PROTECTION / 過電流保護:

The green mode power supply shall be hiccup when any output operating in overload condition (set @ Max load 100~200%) under any line condition for an indefinite period of time. The power supply shall be self-recovery when the fault condition is removed.

在任何時候任何輸入條件，當輸出操作在超載條件最大充電器的（100~200%）時，充電器將進入打嗝模式，當故障被移走後，充電器要能自動恢復到正常

6.2 SHORT—CIRCUIT PROTECTION / 輸出短路保護:

The power supply shall be hiccup and no damage shall occur when any output operating in a short circuit condition under any line condition for an indefinite period of time. The power supply shall be self-recovery when the fault condition is removed.

在任何時候，任何輸入條件下，當輸出操作在短路情況下，充電器將進入打嗝模式，當故障消失後，充電器要能自動恢復正常。

6.3 REVERSE POLARITY PROTECTION/防反接保護

6.3.1. To use Fool-Proof type DC plug. 建議使用防呆式設計的DC連接頭

6.3.2. When Connect wrong polarity, the charger will be self-recovery when fault condition is removed. this function is optional, customer could choose it in according to real requirement.

EDITION	C	PAGE	4/10
---------	---	------	------

ELECTRICAL PERFORMANCE / 電器性能

當錯誤操作，反向連接時，充電器進入保護狀態，直到故障解除。此為選配功能，客戶可根據實際情況選擇。

7. ENVIRONMENTAL CONDITIONS / 環境條件

7.1 OPERATING / 操作條件：

The power supply shall be capable of operating continuously in any mode without performance deterioration in the following environmental conditions.

在下列環境條件下，充電器要能夠連續操作在各種模式，且不能造成性能的退化。

7.1.1 Operation Temperature: $-20^{\circ}\text{C} \sim 40^{\circ}\text{C}$ 工作測度: $-20^{\circ}\text{C} \sim 40^{\circ}\text{C}$

7.1.2 Relative Humidity: 10%~90% 相對濕度: 10%~90%

7.1.3 Vibration: 1.0mm, 10—25Hz, 15 minutes per cycle for each axis (X, Y, Z)

7.1.4 Cooling: The power supply will operate with convection cooling. Blocking of vents must not cause damage to The power supply..

充電器將操作在對流冷卻的環境下，即使將通風口阻塞充電器也不允許有任何損傷發生。

7.2 NON—OPERATING / 非操作條件：

The power supply shall be capable of withstanding the following environmental conditions extended periods of time, without sustaining electrical or mechanical damage and subsequent operational deficiencies:

充電器要能夠長期的經受下列的環境條件，且不允許有電氣級機械方面的損傷和併發的操作的缺失

7.2.1 Storage Temperature: $-30^{\circ}\text{C} \sim 70^{\circ}\text{C}$ 儲存溫度: $-30^{\circ}\text{C} \sim 70^{\circ}\text{C}$

7.2.2 Relative Humidity: 10%~90% 相對濕度: 10%~90%

7.2.3 Color of case and cable / 外殼及線材顏色: Black / 黑色

7.2.4 Vibration and Shock / 振動和衝擊

The power supply shall be designed to withstand normal transportation vibration per MIL—STD—810D, method 514 and procedures X, as it is mounted in the chassis assembly and packed for shipping. 充電器出貨的包裝設計，均要能承受正常運輸的振動，並符合MIL—STD—810D方法514和程式X。

7.2.5 Dropping Testing / 跌落試驗：

X-Y-Z direction 100cm, one time with each direction

X-Y-Z三個方向高度1m每個方向各一次。

8. EMC STANDARDS / 電磁相容性標準

8.1 EMI STANDARDS / EMI 標準

The power supply met the radiated and conducted emission requirements for FCC CLASS B, EN55022 CLASS B.

本充電器符合輻射及傳導要求，滿足FCC CLASS B, EN55022 CLASS B.

8.2 EMS STANDARDS / EMS 標準

The power supply shall meet the following EMS standards:

本充電器滿足下列EMS標準

EDITION	C	PAGE	5/10
----------------	----------	-------------	-------------

ELECTRICAL PERFORMANCE / 電器性能

8.2.1 EN61000-4-2: 1995 / A1: 1998 Electrostatic Discharge(ESD)

8.2.2 EN61000-4-3: 1996 / A1: 1998 Radiated Electromagnetic Fields(RS)

8.2.3 EN61000-4-4: 1995 Electrical Fast Transient / Burst(EFT)

8.2.4 EN61000-4-5: 1995 Lighting Surge Attachment. Line to Neutral: 2KV

9.RELIABILITY AND QUALITY CONTROL / 可靠性及品質控制

9.1 BURN-IN / 老化 The power supply shall undergo a minimum of 4 hours Burn-In test under full load at 40°C ~ ±5°C.
充電器應在40°C ~ ±5°C和滿載條件下老化4小時。

9.2 COMPONENT DERATING / 元件溫度要求 Semiconductor junction temperatures shall not exceed the manufacturer's maximum thermal rating.半導體結溫不允許超過其製造商要求的最大溫度值。

10.WEIGHT / 重量 The weight of the power supply shall be about 250 g. 充電器的重量大約為 250 g

11.MECHANICAL REQUIREMENT / 結構參數

The power supply size:L116*W52*H34mm.外殼尺寸: L116*W52*H34mm

12 INSULATION RESISTANCE / 絕緣阻抗 Input to output: 50M OHM(500VDC)輸入對輸出50兆歐姆(500VDC)

13.LEAKAGE CURRENT / 漏電流

The leakage current shall be less than 0.25mA for class II when power supply is operated maximum input voltage and maximum load.

當充電器操作在最大輸入及最大負載情況下，其漏電流應小於0.25mA，滿足class II等級。

14.MAJOR MEASURE EQUIPMENT / 主要測量設備; VERIFIED BY THE THIRD LAB/外校

- | | | | |
|---|--|--------------------------|---|
| A | AC SOURCE / 交流輸入充電器: AFC-500W,校準頻次: 1次/年 | <input type="checkbox"/> | ✓ |
| B | POWER METER / 充電器功率計: CHROMA 2100,校準頻次: 1次/年 | <input type="checkbox"/> | ✓ |
| C | ELECTRONIC LOAD / 電子負載: PRODIGIT 3310C,校準頻次: 1次/年 | <input type="checkbox"/> | ✓ |
| D | OSCILLOSCOPE / 存儲示波器: TDS-2012B,校準頻次: 1次/年 | <input type="checkbox"/> | ✓ |
| E | DIGITAL MULTIMETER / 數字式萬用表: Fluke 4.5,校準頻次: 1次/年 | <input type="checkbox"/> | ✓ |
| F | DC POWER / 直流輸入充電器: WYK-6030,校準頻次: 1次/年 | <input type="checkbox"/> | ✓ |
| G | HI-POT TESTER / 耐壓測試儀: LANKE 7112,校準頻次: 1次/年 | <input type="checkbox"/> | ✓ |
| H | INSULATION RASISTANCE TESTER / 絕緣電阻表: YD2681A,校準頻次: 1次/年 | <input type="checkbox"/> | ✓ |

EDITION	C	PAGE	6/10
----------------	----------	-------------	-------------

PRODUCT OUTLINE DIMENSION / 產品外觀尺寸(mm)

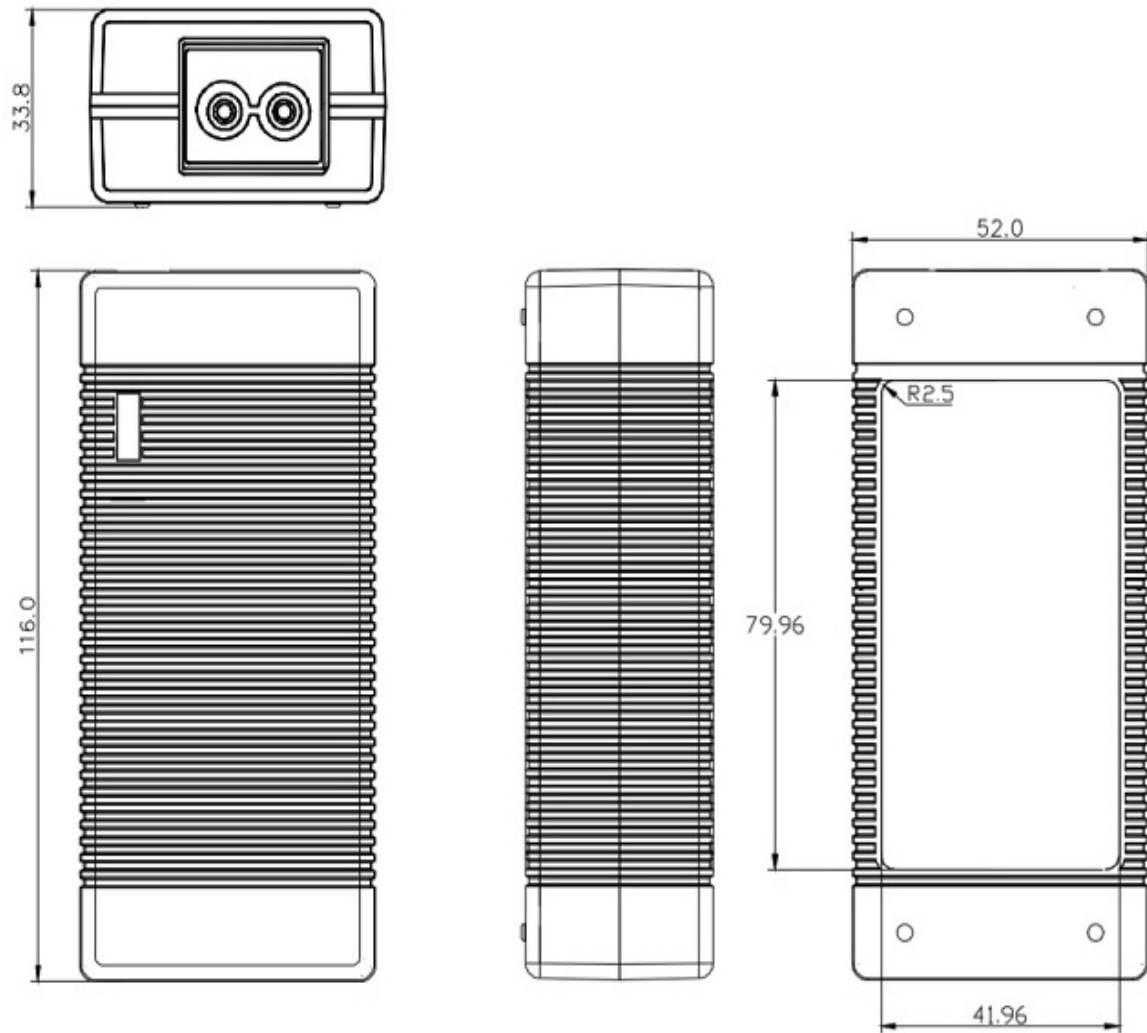

Material/材料: PC

Brand/品牌: GE

Fireproof Class/防火等級: UL94V-0

Color/顏色: Black/黑色

EDITION	C	PAGE	7/10
---------	---	------	------

AC CORD / 輸入電源線 (Optional according to clients' demand)

Versions/版本: A	X16001	Customer: 鑫聚	Customer P/N: AC电源线	
Drawing NO: 图号				

线材 印字	KEMA-KEUR 4VDE DEC 60227-5 300/300V H03VH2-F 2X0.75mm ² CABO FLEXIVEL PLANO IEMMEQU N14440 NEW SQUARE	油中	凹印	√				
7	非绝缘 (wire size)	黑色	包PVC软护套	1	140			
6	绝缘护套 (terminal plug)	橘棕色	φ2.35 葫芦护套	2				
5	绝缘护套 (Type of wire plug)	BK001	MT-18<2.5A 250V~EXE2>	1				
4	绝缘护套	黑色	八字尾护套	1				
3	绝缘护套 (Core specification)	BK001	VDE H03VH2-F 2X0.75mmSQ	1	1185±0.5			
2	绝缘护套 (Type of plug)	BK001	MT-11<2.5A 250V~EXE2>	1				
1	绝缘护套 (Pin of plug)	黑色	欧式截止套	1				
1/1/1/1	FILE 名称	SPECIFICATION	型号 / 规格	COLOR 颜色	QTY# 数量	MATERIAL 材料	SIZE 尺寸	REMARK 备注

尺寸范围	公差	公差	公差	公差	公差
1~6	±1	6.1~10	±2	10.1~20	±3
20.1~50	±4	50.1~100	±8	100.1~1000	±15
>4000	±40	>100	±100	本产品按标准公差	

标题	修改内容	工 程	日期		
赣州永德电业制品有限公司					
TITLE: 名称	Draw: 绘图	2015-10-06			
PLUG & WIRE	绘图				
Unit: 单位	审批				

EDITION	C	PAGE	8/10
---------	---	------	------

DC CORD / 輸出線材

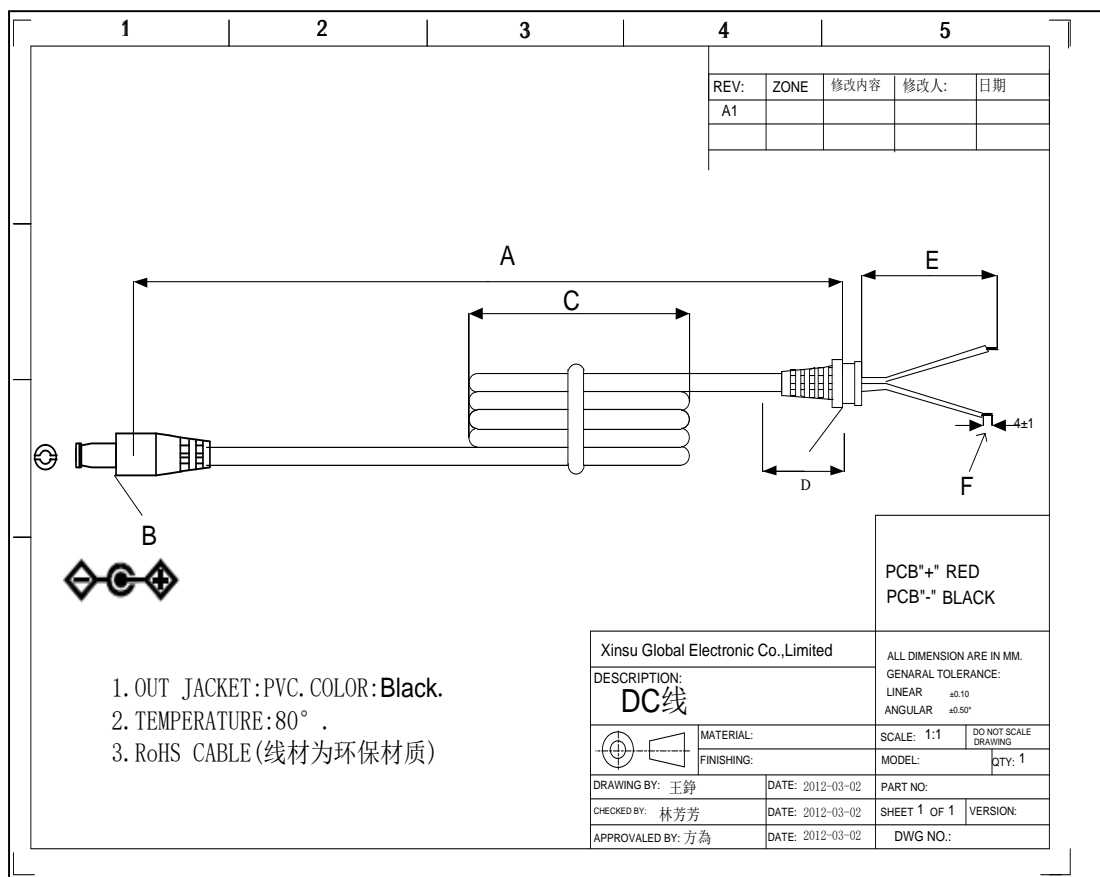

Cable Specification/線材規格

UL 18AWG*2C 2464 L=1.2M Black 80'C

Item No	Part Name (部件名稱)	Description (描述)
A	Length of DC cord(DC線長度)	1.2M
B	Size of DC connector (DC頭尺寸)	OD5.5*ID2.1*L10mm, Inner positive, Outer Negative
C	Length of coil (線包長度)	70MM±10
D	SR NO(線卡編號)	XYX-XL007
E	Length of inlet wire (出線長度)	30MM±1
F	Tinned length (吃錫長度)	4MM±1

EDITION	C	PAGE	9/10
----------------	----------	-------------	-------------

RATING LABEL / 銘牌

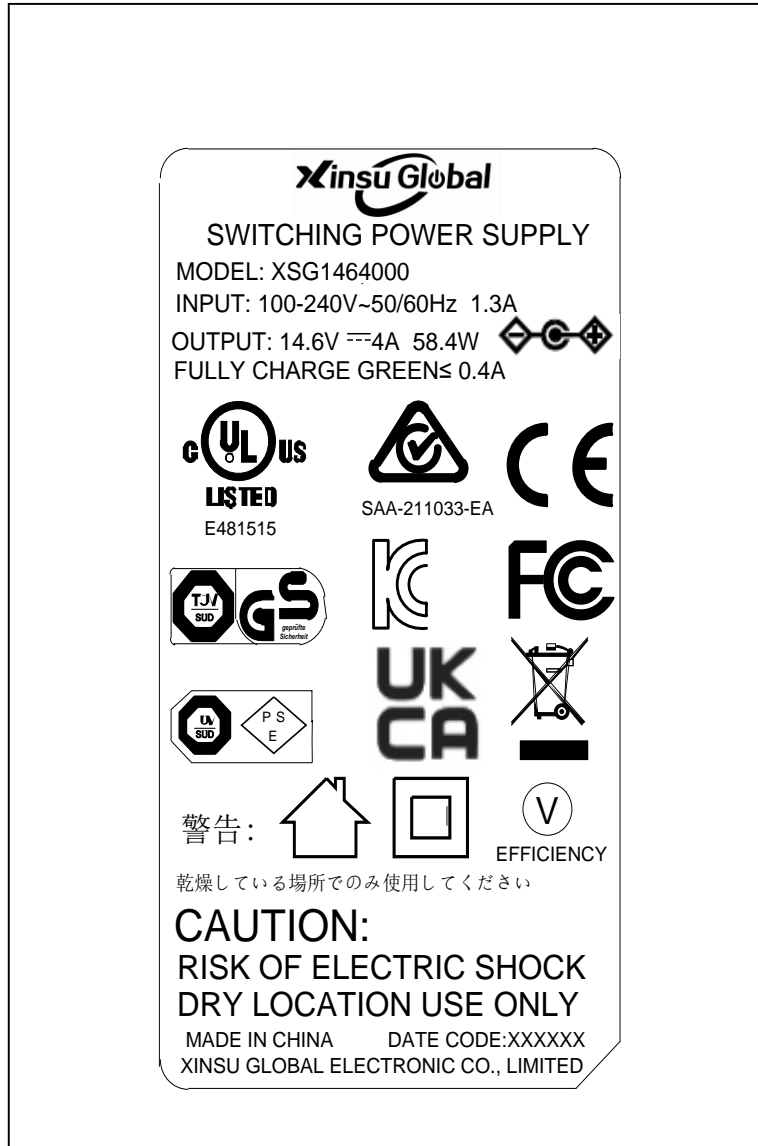

Print/印刷

Laser Carving/鐳雕

1. Silver text on black background 黑底銀字
2. Material: PET 底材為消銀龍.
3. Clear Printing, Wipe Resistance 絲印清晰, 耐擦拭.
4. Gum Permanent 永久背膠.
5. Meet Requirements of Environmental Protection 符合環保要求

EDITION	C	PAGE	10/10
----------------	----------	-------------	--------------